

Switch Ultra

Introducing the new Switch Ultra Range!

A sleek, slimline collection of wiring accessories designed to bring modern style and reliable performance to every space. Locally manufactured with the quality and care you can trust. The range includes switches, plugs, and inserts that combine innovation with everyday practicality. Crafted for those who want more than just functionality, Switch Ultra is where contemporary design meets South African excellence.

Features:

- Thin slimline profile featuring a fluorescent insert
- Available in white and graphite
- Easy and effortless installation and operation
- Locally manufactured
- 12 month warranty
- Fitted with captive screws for ease of installation
- Light switches come standard with 2-way switching
- Same quality - thinner profile

Switch to Quality



Gbi electric

low voltage

a Reunert company



**Local
Product**

**NEW
RANGE!**



Switch Ultra

Wiring Accessories



Wiring Accessories

Enhancing your lifestyle

SWITCH ULTRA Wiring Accessories Range



SUL121-W



SUL123-W



SUL124-W



SUL125-W

NEW RANGE!

Light Switches (2 x 4 - 250 Vac, 16 A, IP20)						WA
Order No.	Description	Price Ea. excl. VAT	Std. Pack	Order No.	Description	Price Ea. excl. VAT
SUL121-W	1 Lever 2 way light switch white	R 44.00	5	SUL121-G	1 Lever 2 way light switch graphite	R 74.00
SUL123-W	2 Lever 2 way light switch white	R 69.00	5	SUL123-G	2 Lever 2 way light switch graphite	R 107.00
SUL124-W	3 Lever 2 way light switch white	R 71.00	5	SUL124-G	3 Lever 2 way light switch graphite	R 109.00
SUL125-W	4 Lever 2 way light switch white	R 81.00	5	SUL125-G	4 Lever 2 way light switch graphite	R 122.00



SUG021-W

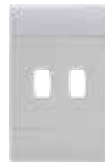

SUG022-W



SUG023-W



SUG024-W



SUG020-W



SUSR024-W

Blanking / Grid Plates 2 x 4						WA
Order No.	Description	Price Ea. excl. VAT	Std. Pack	Order No.	Description	Price Ea. excl. VAT
SUG021-W	2 x 4 Grid plate 1 lever white	R 26.00	10	SUG021-G	2 x 4 Grid plate 1 lever graphite	R 51.00
SUG022-W	2 x 4 Grid plate 2 lever white	R 26.00	10	SUG022-G	2 x 4 Grid plate 2 lever graphite	R 51.00
SUG023-W	2 x 4 Grid plate 3 lever white	R 26.00	10	SUG023-G	2 x 4 Grid plate 3 lever graphite	R 51.00
SUG024-W	2 x 4 Grid plate 4 lever white	R 26.00	10	SUG024-G	2 x 4 Grid plate 4 lever graphite	R 51.00
SUG020-W	2 x 4 Blanking plate white	R 26.00	10	SUG020-G	2 x 4 Blanking plate white graphite	R 51.00
SUSR024-W	2 x 4 Surround 2 piece top & bottom white	R 12.00	10	SUSR024-G	2 x 4 Surround 2 piece top & bottom graphite	R 14.00



SUG040-W



SUG041-W



SUG042-W



SUSR044-W

Blanking / Grid Plates 4 x 4						WA
Order No.	Description	Price Ea. excl. VAT	Std. Pack	Order No.	Description	Price Ea. excl. VAT
SUG040-W	4 x 4 Blanking plate white	R 31.00	10	SUG040-G	4 x 4 Blanking plate graphite	R 64.00
SUG041-W	4 x 4 Grid plate 1 lever white	R 42.00	10	SUG041-G	4 x 4 Grid plate 1 lever graphite	R 78.00
SUG042-W	4 x 4 Grid plate 2 lever white	R 42.00	10	SUG042-G	4 x 4 Grid plate 2 lever graphite	R 78.00
SUSR044-W	4 x 4 Surround 2 piece top & bottom white	R 18.00	10	SUSR044-G	4 x 4 Surround 2 piece top & bottom graphite	R 20.00

Should you require a special combination please contact CBI.

SWITCH ULTRA Wiring Accessories Range

NEW RANGE!



SUP672-W

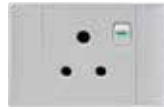

SUP673-W



SUP681-W



Switched Socket Outlets (2 x 4 - 250 Vac, 16 A, IP20)					WA	
Order No.	Description	Price Ea. excl. VAT	Std. Pack	Order No.	Description	Price Ea. excl. VAT
SUP672-W	Single switched socket outlet vertical standard white	R 81.00	5	SUP672-G	Single switched socket outlet vertical graphite	R 103.00
SUP673-W	Single switched socket outlet standard horizontal white	R 81.00	5	SUP673-G	Single switched socket outlet horizontal graphite	R 103.00
SUP681-W	SA/EU combined socket outlet vertical white	R 106.00	5	SUP681-G	SA/EU combined socket outlet vertical graphite	R 136.00



SUP674-W



SUP675-W



SUP680-W



SUP683-W



PS685USBC-P



SUP693-W

Socket Outlets (4 x 4 - 250 Vac, 16 A, IP20)					WA	
Order No.	Description	Price Ea. excl. VAT	Std. Pack	Order No.	Description	Price Ea. excl. VAT
SUP674-W	Single switched socket outlet white	R 97.00	5	SUP674-G	Single switched socket outlet graphite	R 127.00
SUP675-W	Double switched socket outlet white	R 131.00	5	SUP675-G	Double switched socket outlet graphite	R 164.00
SUP680-W	SA / EU combined switched socket outlet white	R 131.00	5	SUP680-G	SA / EU combined switched socket outlet graphite	R 164.00
SUP683-W	Single socket outlet with 3 x Euro sockets white	R 194.00	5	SUP683-G	Single socket outlet with 3 x Euro sockets graphite	R 233.00
PS685USBC-P	USB Type A & C / SA / Euro switched socket outlet white	R 595.00	5	PS685USBC-G	USB Type A & C / SA / Euro switched socket outlet graphite	R 674.00
SUP693-W	SA / Schuko / Euro combo switched white	R 145.00	5	SUP693-G	SA / Schuko / Euro combo switched graphite	R 179.00



SUP679-W

Unswitched Socket Outlet (250 Vac, 5 A, IP20)			WA	
Order No.	Description	Std. Pack	Price Ea. excl. VAT	
SUP679-W	Unswitched socket outlet round white	10	R 41.00	



SUP676-R



SUP677-R

Dedicated Switched Socket Outlet (250 Vac, 16 A, IP20)			WA	
Order No.	Description	Std. Pack	Price Ea. excl. VAT	
SUP676-R	4 x 4 Single switched dedicated socket outlet red	5	R 148.00	
SUP677-R	4 x 4 Double switched dedicated socket outlet red	5	R 200.00	

SWITCH ULTRA Wiring Accessories Range



SUI129-W / SUI131-W



Switch Disconnectors (4 x 4 - 2 and 3 Pole, 250 Vac, 60 A, IP20)						WA
Order No.	Description	Price Ea. excl. VAT	Std. Pack	Order No.	Description	Price Ea. excl. VAT
SUI129-W	4 x 4 Stove isolator 2P white	R 159.00	4	SUI129-G	4 x 4 Stove isolator 2P graphite	R 230.00
SUI131-W	4 x 4 Stove isolator 3P white	R 250.00	4	SUI131-G	4 x 4 Stove isolator 3P graphite	R 349.00



SUI130-W

Switch Disconnectors (2 x 4 - 2 Pole, 250 Vac, 30 A, IP20)						WA
Order No.	Description	Price Ea. excl. VAT	Std. Pack	Order No.	Description	Price Ea. excl. VAT
SUI130-W	2 x 4 Geyser isolator 2P white	R 140.00	5	SUI130-G	2 x 4 Geyser isolator 2P graphite	R 206.00



SULI660-P



SULI661-P



SUII663-W

Switch Inserts (IP20)						WA
Order No.	Description	Price Ea. excl. VAT	Std. Pack	Order No.	Description	Price Ea. excl. VAT
SULI660-W	Light switch insert 2 way 16 A white	R 30.00	20	SULI660-G	Switch insert 2 way graphite	R 46.00
SULI661-W	Dimmer switch insert 16 A white	R 35.00	20	SULI661-G	Dimmer switch insert 16 A graphite	R 53.00
SUII663-W	2P switch insert 20 A white	R 84.00	20	SUII663-G	2P switch insert 20 A graphite	R 109.00
SULI664-W	Intermediate switch insert 16 A white	R 120.00	20	SULI664-G	Intermediate switch insert 16 A graphite	R 156.00

Wiring Accessories Range



L120-P / L121-P



L122-P / L123-P



L124-P



L125-P

Light Switches (2 x 4 - 250 Vac, 16 A, IP20)						WA
Order No.	Description	Price Ea. excl. VAT	Std. Pack	Order No.	Description	Price Ea. excl. VAT
L120-P	1 Lever 1 way light switch white	R 41.00	5	L120C03-T	1 Lever 1 way light switch silver shimmer	R 102.00
L121-P	1 Lever 2 way light switch white	R 47.00	5	L121C03-T	1 Lever 2 way light switch silver shimmer	R 107.00
L122-P	2 Lever 1 way light switch white	R 55.00	5	L122C03-T	2 Lever 1 way light switch silver shimmer	R 116.00
L123-P	2 Lever 2 way light switch white	R 72.00	5	L123C03-T	2 Lever 2 way light switch silver shimmer	R 133.00
L124-P	3 Lever 1 way light switch white	R 74.00	5	L124C03-T	3 Lever 1 way light switch silver shimmer	R 135.00
L125-P	4 Lever 1 way light switch white	R 85.00	5	L125C03-T	4 Lever 1 way light switch silver shimmer	R 147.00



L126-P



L127-P

Light Switches (4 x 4 - 250 Vac, 16 A, IP20)						WA
Order No.	Description	Price Ea. excl. VAT	Std. Pack	Order No.	Description	Price Ea. excl. VAT
L126-P	4 Lever 1 way light switch white	R 109.00	5	L126C03-T	4 Lever 1 way light switch silver shimmer	R 190.00
L127-P	6 Lever 1 way light switch white	R 138.00	5	L127C03-T	6 Lever 1 way light switch silver shimmer	R 219.00



G000-P



G001-P



G002-P



G003-P



G009-P



S013R-P

Blanking / Grid Plates 2 x 4						WA
Order No.	Description	Price Ea. excl. VAT	Std. Pack	Order No.	Description	Price Ea. excl. VAT
G000-P	2 x 4 Grid plate 1 lever white	R 28.00	10	G000C03-T	2 x 4 Grid plate 1 lever silver shimmer	R 88.00
G001-P	2 x 4 Grid plate 2 lever white	R 28.00	10	G001C03-T	2 x 4 Grid plate 2 lever silver shimmer	R 81.00
G002-P	2 x 4 Grid plate 3 lever white	R 28.00	10	G002C03-T	2 x 4 Grid plate 3 lever silver shimmer	R 81.00
G003-P	2 x 4 Grid plate 4 lever white	R 28.00	10	G003C03-T	2 x 4 Grid plate 4 lever silver shimmer	R 88.00
G009-P	2 x 4 Blanking plate white	R 28.00	10	G009C03-T	2 x 4 Blanking plate silver shimmer	R 83.00
S013R-P	2 x 4 Surround 2 piece top & bottom	R 12.00	10	N/A		



G004-P



G005-P



G010-P



S014R-P

Blanking / Grid Plates 4 x 4						WA
Order No.	Description	Price Ea. excl. VAT	Std. Pack	Order No.	Description	Price Ea. excl. VAT
G010-P	4 x 4 Blanking plate white	R 32.00	10	G010C03-T	Blanking plate silver shimmer	R 93.00
G004-P	4 x 4 Grid plate 1 lever white	R 44.00	10	G006-P	4 x 4 Grid plate 3 lever white	R 38.00
G005-P	4 x 4 Grid plate 2 lever white	R 44.00	10	G007-P	4 x 4 Grid plate 4 lever white	R 46.00
S014R-P	4 x 4 Surround 2 piece top & bottom	R 19.00	10	G008-P	4 x 4 Grid plate 6 lever white	R 42.00

Should you require a special combination please contact CBI.

Wiring Accessories Range



PS672-P



PS673-P



PS681-P



Switched Socket Outlets (2 x 4 - 250 Vac, 16 A, IP20)						WA
Order No.	Description	Price Ea. excl. VAT	Std. Pack	Order No.	Description	Price Ea. excl. VAT
PS672-P	Single switched socket outlet vertical standard white	R 85.00	5	PS672C03-T	Single switched socket outlet vertical silver shimmer	R 147.00
PS673-P	Single switched socket outlet standard horizontal white	R 85.00	5	PS673C03-T	Single switched socket outlet horizontal silver shimmer	R 147.00
PS681-P	SA/EU combined socket outlet vertical white	R 111.00	5	PS681C03-T	SA/EU combined socket outlet vertical silver shimmer	R 173.00



PS674R-P



PS675R-P



PS680-P



PS682R-P



PS683R-P



PS685USB-P

Socket Outlets (4 x 4 - 250 Vac, 16 A, IP20)						WA
Order No.	Description	Price Ea. excl. VAT	Std. Pack	Order No.	Description	Price Ea. excl. VAT
PS674R-P	Single switched socket outlet white	R 102.00	5	PS674C03-T	Single switched socket outlet silver shimmer	R 183.00
PS675R-P	Double switched socket outlet white	R 138.00	5	PS675C03-T	Double switched socket outlet silver shimmer	R 219.00
PS680-P	SA/EU combined switched socket outlet white	R 138.00	5	PS680C03-T	SA/EU combined switched socket outlet silver shimmer	R 219.00
PS682R-P	6 Way Euro socket outlet	R 138.00	5	N/A		
PS683R-P	Single socket outlet with 3 x Euro sockets	R 204.00	5	N/A		
PS685USB-P	USB / SA / Euro switched socket outlet white	R 625.00	5	PS685USB C03-T	USB / SA / Euro switched socket outlet silver shimmer	R 743.00



PS678-P



PS679-P

Unswitched Socket Outlet (250 Vac, 6 A, IP20)				WA
Order No.	Description	Std. Pack	Price Ea. excl. VAT	
PS678-P	2 x 4 Unswitched socket outlet white	10	R 59.00	
PS679-P	Unswitched socket outlet round white	10	R 43.00	



PS671-P



PS676R-P



PS677R-P

Dedicated Switched Socket Outlet (250 Vac, 16 A, IP20)				WA
Order No.	Description	Std. Pack	Price Ea. excl. VAT	
PS671-P	2 x 4 Single switched dedicated socket outlet horizontal red	5	R 108.00	
PS676R-P	4 x 4 Single switched dedicated socket outlet red	5	R 155.00	
PS677R-P	4 x 4 Double switched dedicated socket outlet red	5	R 211.00	

Wiring Accessories Range



OB690



OB878

Surface Mount Outlet Boxes			WA
Order No.	Description	Std. Pack	Price Ea. excl. VAT
OB690	Surface mount 2 x 4 outlet box (plastic)	10	R 28.00
OB878	Surface mount 4 x 4 outlet box (plastic)	10	R 33.00



I129-P / I131-P

Switch Disconnectors (4 x 4 - 2 and 3 Pole, 250 Vac, 60 A, IP20)						WA
Order No.	Description	Price Ea. excl. VAT	Std. Pack	Order No.	Description	Price Ea. excl. VAT
I129-P	Stove isolator 2P white	R 167.00	4	I129C03-T	Stove isolator 2P silver shimmer	R 248.00
I131-P	Stove isolator 3P white	R 331.00	4	I131C03-T	Stove isolator 3P silver shimmer	R 412.00



I130-P

Switch Disconnectors (2 x 4 - 2 Pole, 250 Vac, 30 A, IP20)						WA
Order No.	Description	Price Ea. excl. VAT	Std. Pack	Order No.	Description	Price Ea. excl. VAT
I130-P	Geyser isolator 2P white	R 147.00	5	I130C03-T	Geyser isolator 2P silver shimmer	R 207.00



TV678-P



B133-P



T686-P

TV & Telephone Socket Outlets and Bell Push (2 x 4 - 250 Vac, 16 A, IP20)						WA
Order No.	Description	Price Ea. excl. VAT	Std. Pack	Order No.	Description	Price Ea. excl. VAT
TV678-P	Single TV socket outlet white	R 157.00	5	TV678C03-T	Single TV socket outlet silver shimmer	R 217.00
B133-P	Bell push socket outlet white	R 69.00	5	B133C03-T	Bell push socket outlet silver shimmer	R 129.00
T686-P	Single telephone socket outlet (RJ11) white	R 135.00	5	T686C03-T	Single telephone socket outlet (RJ11) silver shimmer	R 195.00



NS-116



NS-216



NS-316



NS-416

Day / Night Switches (250 Vac, 25 A, IP54)			AB
Order No.	Description	Std. Pack	Price Ea. excl. VAT
NS-116	Conduit entry model day / night switch	1	R 195.00
NS-216	Bracket and cable day / night switch	1	R 200.00
NS-316	Modular version day / night switch	1	R 200.00
NS-416	Nema base connection version day / night switch*	1	R 200.00

* NS-416 does not come complete with the base

Wiring Accessories Range



DI645-P



TI657-P



II662-P



TVI663-P



TVI664-P

Neon, TV, DSTV and Telephone Inserts						WA
Order No.	Description	Price Ea. excl. VAT	Std. Pack	Order No.	Description	Price Ea. excl. VAT
DI645-P	Data socket insert (RJ45)	R 133.00	20	N/A		
TI657-P	Telephone socket insert RJ11 white	R 109.00	20	TI657C03-T	Telephone socket insert RJ11 silver shimmer	R 126.00
II662-P	Indication light insert red	R 53.00	20	N/A		
TVI663-P	Standard TV connection insert white	R 126.00	20	TVI663C03-T	Standard TV connection insert silver shimmer	R 141.00
TVI664-P	DSTV connection insert white	R 124.00	20	TVI664C03-T	DSTV connection insert silver shimmer	R 140.00



LI659-P



LI660-P



LI661-P



LI662-P



LI663-P / II663-P



BI661-P

Switch Inserts (IP20)						WA
Order No.	Description	Price Ea. excl. VAT	Std. Pack	Order No.	Description	Price Ea. excl. VAT
LI659-P	Light switch insert 1 way 16 A white	R 22.00	20	LI659C03-T	Switch insert 1 way silver shimmer	R 38.00
LI660-P	Light switch insert 2 way 16 A white	R 31.00	20	LI660C03-T	Switch insert 2 way silver shimmer	R 47.00
LI661-P	Dimmer switch insert 16 A white	R 36.00	20	LI661C03-T	Dimmer switch insert 16 A silver shimmer	R 53.00
LI662-P	Blank switch insert white	R 7.00	20	LI662C03-T	Blank switch insert silver shimmer	R 22.00
LI663-P	2P switch insert 16 A white	R 64.00	20	LI663C03-T	2P switch insert 16 A silver shimmer	R 81.00
II663-P	2P switch insert 20 A white	R 88.00	20	II663C03-T	2P switch insert 20 A silver shimmer	R 105.00
LI664-P	Intermediate switch insert 16 A white	R 126.00	20	LI664C03-T	Intermediate switch insert 16 A silver shimmer	R 141.00
BI661-P	Bell push insert 4 A white	R 41.00	20	BI661C03-T	Bell push insert 4 A silver shimmer	R 57.00



D500LED-P



D500LEDC-P

Tactile Dimmer Module (LED & Halogen Compatible)				WA
Order No.	Description	Std. Pack	Price Ea. excl. VAT	
D500LED-P	Dimmer module (250 Vac, 500 W)	1	R 645.00	
D500LEDC-P	Complete dimmer unit (G000-P, LI661-P, D500LED-P)	1	R 687.00	

Wiring Accessories Range Grid Plate Selection Guide

Switch to Flexibility...

Wiring Accessories

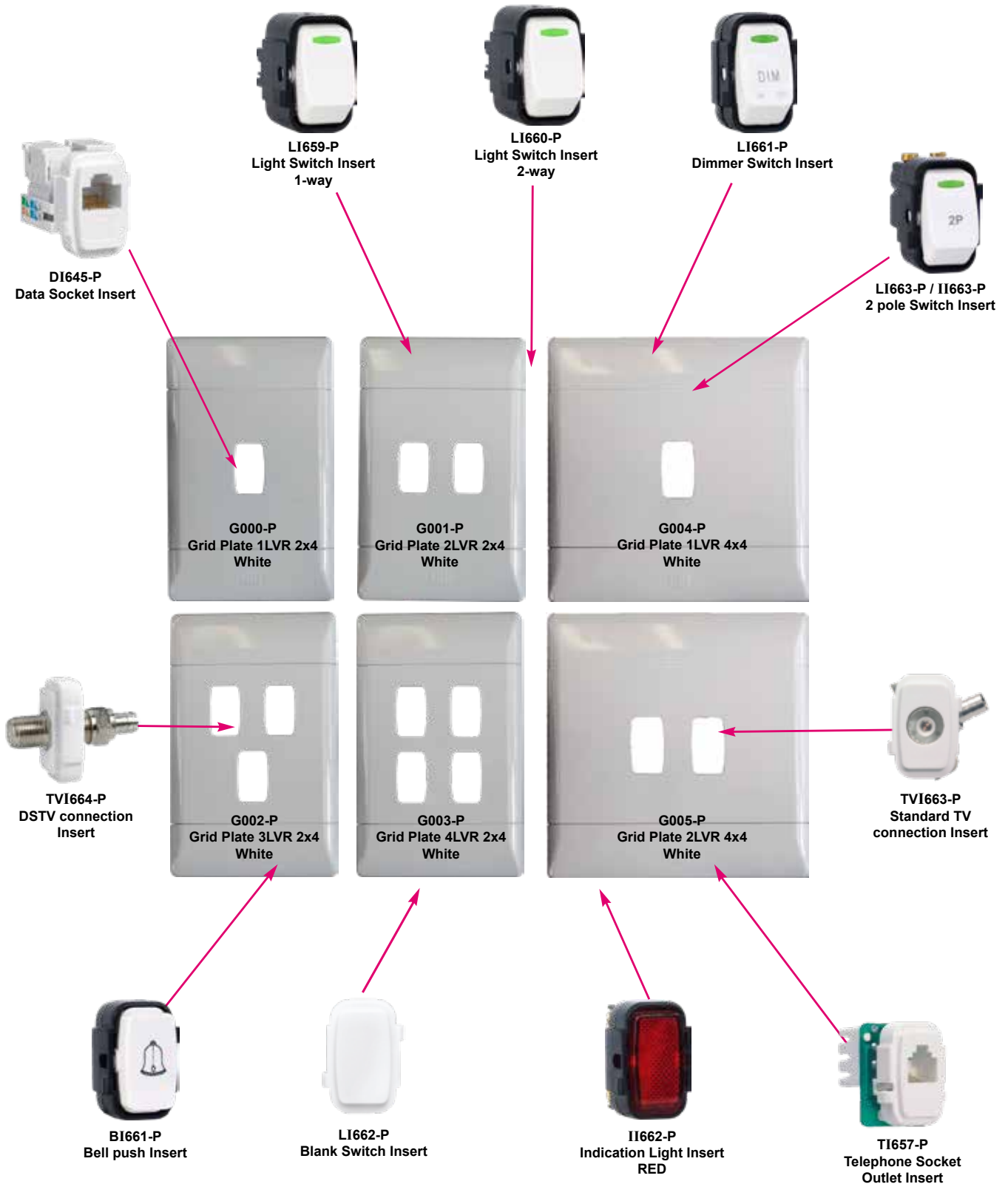

Populate as needed starting from the grid plate as base

D500LED-P Dimmer Trailing Edge

Wiring diagrams

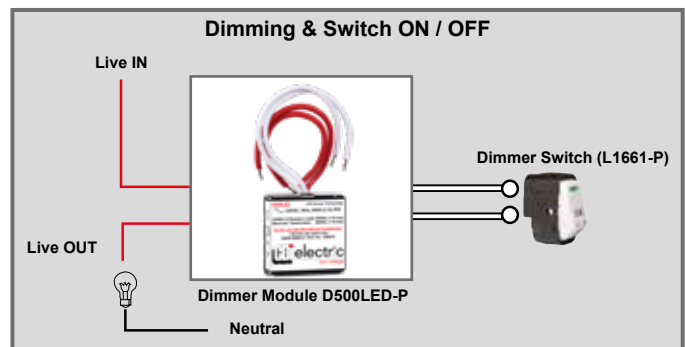
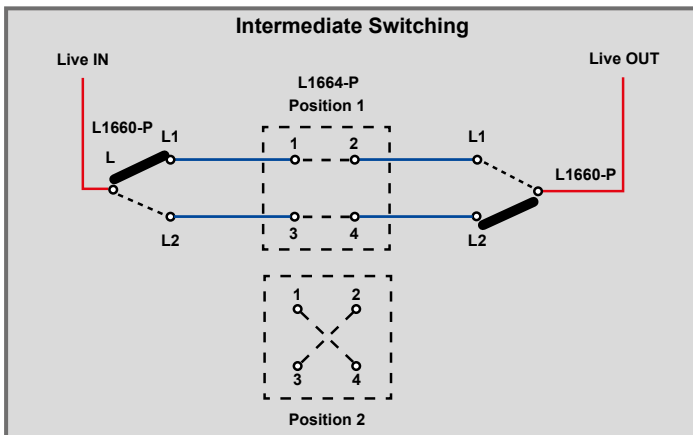
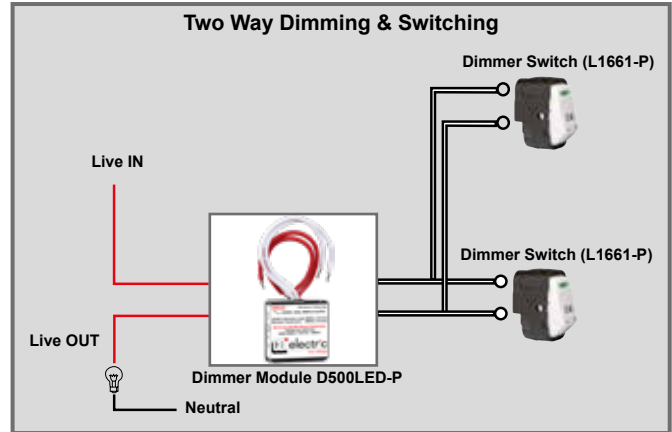
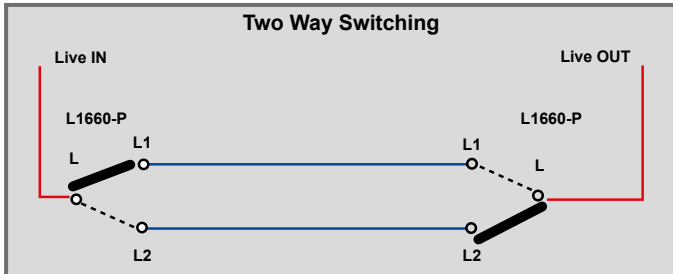

500 W Universal Dimmer (D500LED-P)		WA
Load Tables	Minimum Load	Maximum Load
12 V low voltage electronic transformer	3 W	500 W
230 Vac mains incandescent halogen		500 W
230 Vac mains LED lamps		500 "equivalent" W

Notes:

LED rating of load on dimmers:

Max Watts: Use max replacement wattage. E.g. 3 W LED = 40 W equivalent Watts